

Front Suspension:

Ride Height: _____
Camber: _____
Toe: _____
Anti-Roll Bar
Size: _____
Gap: _____
Ackerman
Notes: _____
Drive Shaft: CVAs: Universals:
Chassis Brace: Short: Long:
Hex: _____
Notes: _____

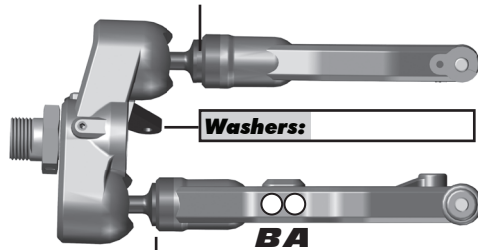

Caster Shim: _____
Upper Ball Type: _____
Upper Ball Shim: _____
Washers: _____
Lower Ball Shim: _____

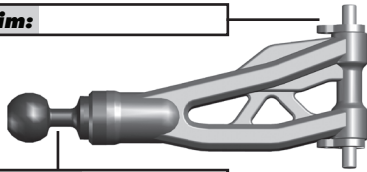

Wheelbase Shim: _____
Lower Ball Type: _____
Upper Arm Mount: _____
Arm Mount A: _____
Arm Mount B: _____

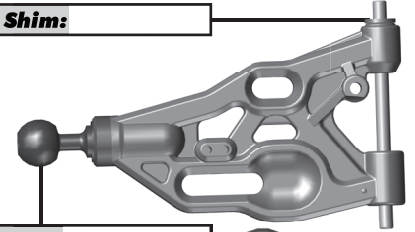

Rear Suspension:

Ride Height: _____
Camber: _____
Anti-Roll Bar
Size: _____
Gap: _____
Drive Shaft: CVAs: Universals:
Chassis Brace: Short: Long:
Hex: _____
Notes: _____

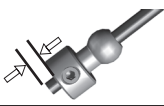

Hub Shim: _____
Wheelbase Shim: _____
Arm Mount C: _____
Arm Mount D: _____

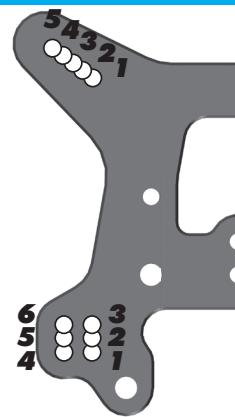
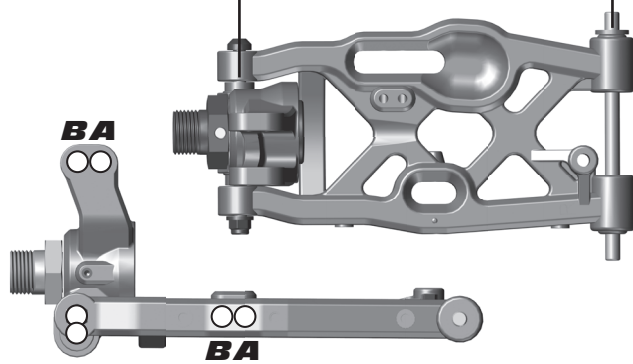

Electronics and Engine:

Radio: _____
Receiver Battery: _____
Throttle Servo: _____
Steering Servo: _____
EPA: Throttle: _____ % Brake: _____ %
Brake Bias: _____ **D/R:** _____ %
Engine: _____ **Temp:** _____
Muffler: _____ **Fuel:** _____
Restrictor: _____ **Glow Plug:** _____
Notes: _____

Differential:

	Fluid	Gear Set	Planet O-Rings
Front:	_____	_____	_____
Center:	_____	_____	_____
Rear:	_____	_____	_____

Clutch and Gearing:

Spur Gear: _____ **Bell:** _____
Shoes: _____
Springs: _____
Notes: _____

Shocks:

	Front	Rear
Piston:	_____	_____
Fluid:	_____	_____
Cap:	_____	_____
Rebound:	_____	_____
Spring:	_____	_____
Free Length:	_____	_____
Notes:	_____	

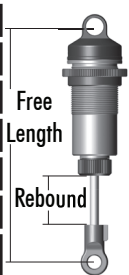

Track Info:

Size: Small Medium Large Extra Large
Surface: Dirt Carpet Astroturf Multi Surface
Traction: Low Medium High Very High
Moisture: Dry Damp Wet
Condition: Indoor Outdoor Dusty Hard Packed
 Bumpy Grooved Smooth Loamy
Temperature: Ambient: _____ Track: _____
Notes: _____

Tires:

Front Tires: _____
Front Compound: _____
Front Insert: _____
Rear Tires: _____
Rear Compound: _____
Rear Insert: _____
Wheel (F/R): _____
Notes: _____

Body, Wings:

Body: _____
Wing: _____
Wing Height: High: Low:
Gap to Tower: _____
Weight: _____
Total Vehicle Weight: _____
Notes: _____

Vehicle Comments:

Notes: _____